

**Product Description**

Force Sensitive Resistor are resistive sensor exhibiting vary resistance that responds to force applied to the sensing area. As force on the sensor is increased, resistance is decreased.

For the single-zone sensors, as the sensor is a Two-terminal device that can essentially be treated as a variable resistor whose value is controlled by applied force, and also a switch whose threshold is controlled by applied force and setting up.

The sensors are made up of robust polyester film, high-conductive material and Nano-sized force sensing material. The top layer of the sensor consists of the area of force sensitive layer on a flexible film. And bottom layer is comprised of conductive circuit traces on a flexible film. And the above two layers are stick together by spacer adhesive and active area is without adhesive. When the active area is applied force, force sensitive layer on the top layer shunts the circuit traces on the bottom, varying resistance output terminals.

- Static / dynamic pressure sensing
- Quick response
- Durable long life
- Customized design

**Technical Data And Physical Properties**

Thickness	0.30mm With Rear ADH	
Shape	flexible	
Actuation force	20g, Res.<=200KΩ	
Sensitivity range	20g to 3Kg	
Resolution	continuous	
Non-actuated resistance	>10M Ω	
Response time	<10us	
Operating temperature	-40℃ ~+ 85℃	
Life time	>1 million	
Repeatability Same part	+/-3%, R@1000g	Average
Repeatability part to part	+/-10% R@1000g	Average
Hysteresis	+ 10% , (RF+ - RF- )/FR+ , 1000g	
EMI	Generates no EMI	
EDS	not ESD sensitive	
Drift	<5%, 1kg load, 24H	
RoHS		

**Force curve**

The following plot shows an example response resistance curve, when the sensor actuated by a force curve tester.

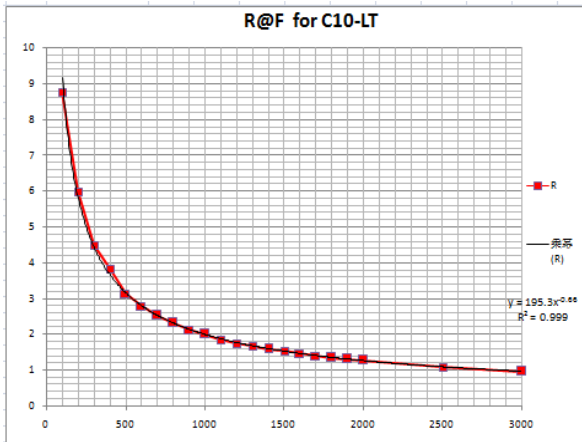

The following plot shows an near-linear curve which is  $1/R @F$ .

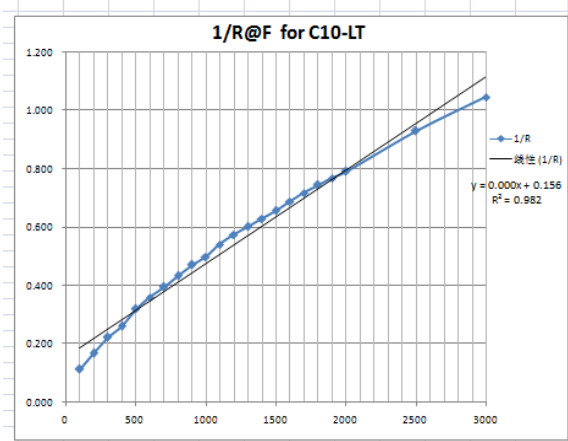

## Application Circuit

### 1. Voltage Divider

The sensor is placed in series with a fixed resistor ( $R_0$ ), and output voltage is measured across  $R_0$ . It is given by  $V_{out} = V_{cc} * R_0 / (R_0 + R_s)$ .

How to define the fixed resistor value, Basically,  $R_0$  is  $1/3$  to  $1/2$  of the resistance range of  $R_s$ . What's more, if  $R_0$  is appropriate, you can get a near-linear curve of Force vs  $V_{out}$  in a special force range. Depending on the impedance requirements of the measuring circuit, the voltage divider could be followed by an

op-amp.

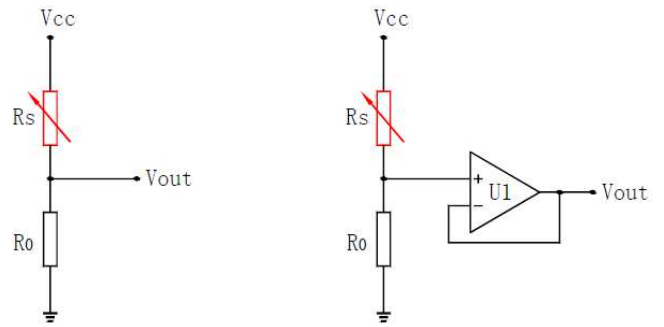

Vout(V)

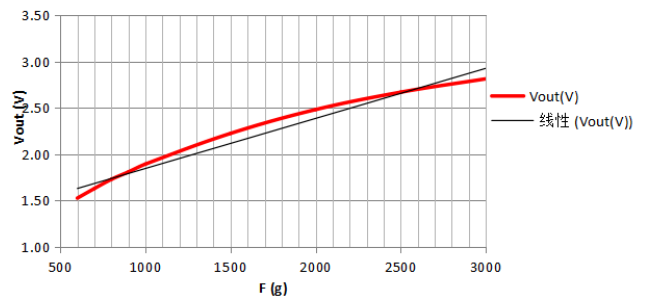

### 2. Force Threshold Switch

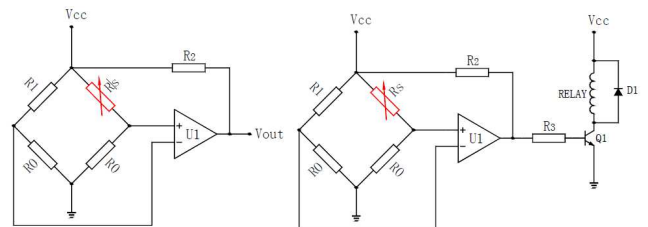

This is an ideal circuit for applications that require on-off switching at a specified force. It consists a Wheatstone bridge circuit and a voltage comparator.

When apply force and  $R_s$  becomes to be lower than  $R_1$ , lead  $U_1+$  to be higher than  $U_1-$ , and  $V_{out}$  becomes to be high. This high level signal can used to be trigger signal of following devices, for example, it can trigger a relay, and then control LEDs, buzzer warning, motor and other load devices.

## Custom sensors

We can design specialized sensors to meet the customers' unique requirements. It is including specialized shape and size, specialized force vs. resistance

characteristic, special material and thickness, unique active area shape and quantity, and also connection options.

### Mechanical data of C10-LT

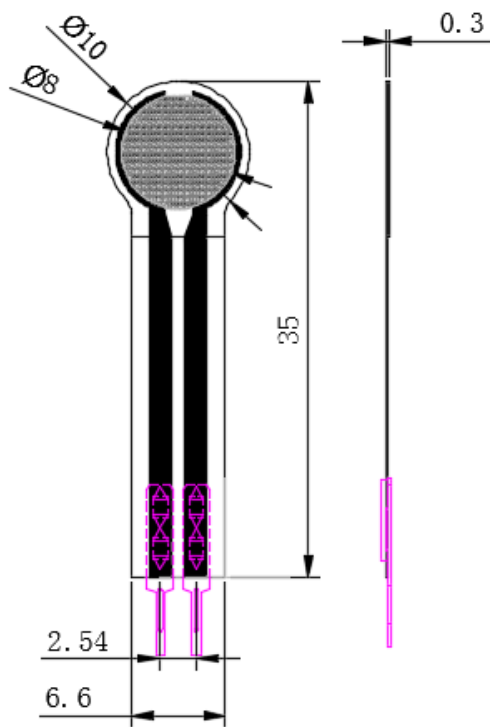

#### Note:

The above information is considered correct and is prepared for professional, competent users who are able to properly evaluate and use these data. Film sensor Technology Co., Ltd does not guarantee the accuracy of these data, the use of the damage occurred in the process of no responsibility.

### Product Description

Force Sensitive Resistor are resistive sensor exhibiting vary resistance that responds to force applied to the sensing area. As force on the sensor is increased, resistance is decreased.

For the single-zone sensors, as the sensor is a Two-terminal device that can essentially be treated as a variable resistor whose value is controlled by applied force, and also a switch whose threshold is controlled by applied force and setting up.

The sensors are made up of robust polyester film, high-conductive material and Nano-sized force sensing material. The top layer of the sensor consists of the area of force sensitive layer on a flexible film. And bottom layer is comprised of conductive circuit traces on a flexible film. And the above two layers are stick together by spacer adhesive and active area is without adhesive. When the active area is applied force, force sensitive layer on the top layer shunts the circuit traces on the bottom, varying resistance output terminals.

- Static / dynamic pressure sensing
- Quick response
- Durable long life
- Customized design

### Technical Data And Physical Properties

Thickness	0.30mm With Rear ADH	
Shape	flexible	
Actuation force	20g, Res.<=200KΩ	
Sensitivity range	20g to 3Kg	
Resolution	continuous	
Non-actuated resistance	>10M Ω	
Response time	<10us	
Operating temperature	-40℃ ~+ 85℃	
Life time	>1 million	
Repeatability Same part	+/-3%, R@1000g	Average
Repeatability part to part	+/-10% R@1000g	Average
Hysteresis	+ 10% , (RF+ - RF- )/FR+ , 1000g	
EMI	Generates no EMI	
EDS	not ESD sensitive	
Drift	<5%, 1kg load, 24H	
RoHS		

### Force curve

The following plot shows an example response resistance curve, when the sensor actuated by a force curve tester.

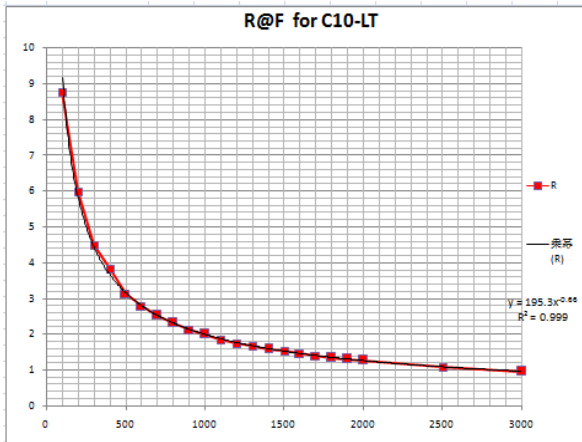

The following plot shows an near-linear curve which is  $1/R @F$ .

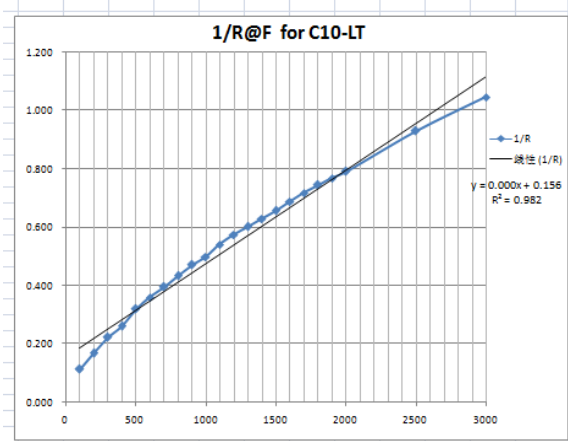

## Application Circuit

### 1. Voltage Divider

The sensor is placed in series with a fixed resistor ( $R_0$ ), and output voltage is measured across  $R_0$ . It is given by  $V_{out} = V_{cc} * R_0 / (R_0 + R_s)$ .

How to define the fixed resistor value, Basically,  $R_0$  is  $1/3$  to  $1/2$  of the resistance range of  $R_s$ . What's more, if  $R_0$  is appropriate, you can get a near-linear curve of Force vs  $V_{out}$  in a special force range. Depending on the impedance requirements of the measuring circuit, the voltage divider could be followed by an

op-amp.

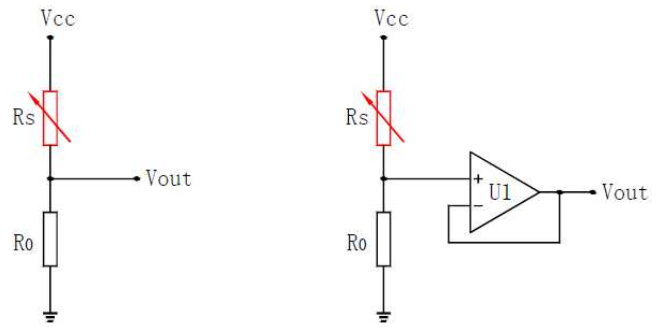

Vout(V)

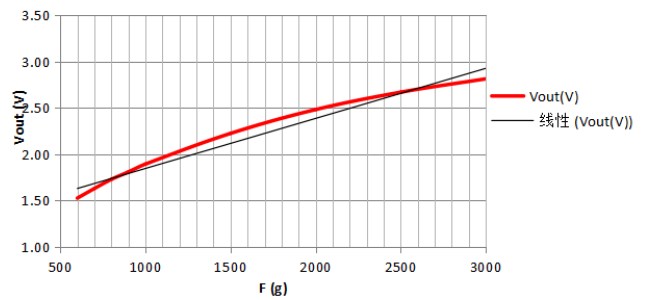

### 2. Force Threshold Switch

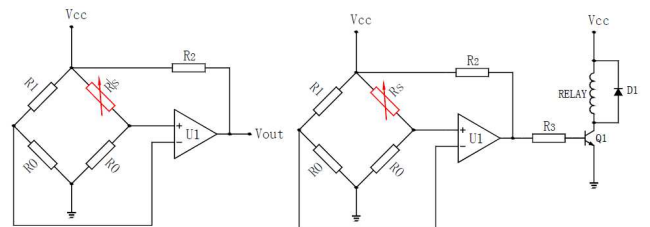

This is an ideal circuit for applications that require on-off switching at a specified force. It consists a Wheatstone bridge circuit and a voltage comparator.

When apply force and  $R_s$  becomes to be lower than  $R_1$ , lead  $U_1+$  to be higher than  $U_1-$ , and  $V_{out}$  becomes to be high. This high level signal can used to be trigger signal of following devices, for example, it can trigger a relay, and then control LEDs, buzzer warning, motor and other load devices.

## Custom sensors

We can design specialized sensors to meet the customers' unique requirements. It is including specialized shape and size, specialized force vs. resistance

characteristic, special material and thickness, unique active area shape and quantity, and also connection options.

### Mechanical data of C10-LT

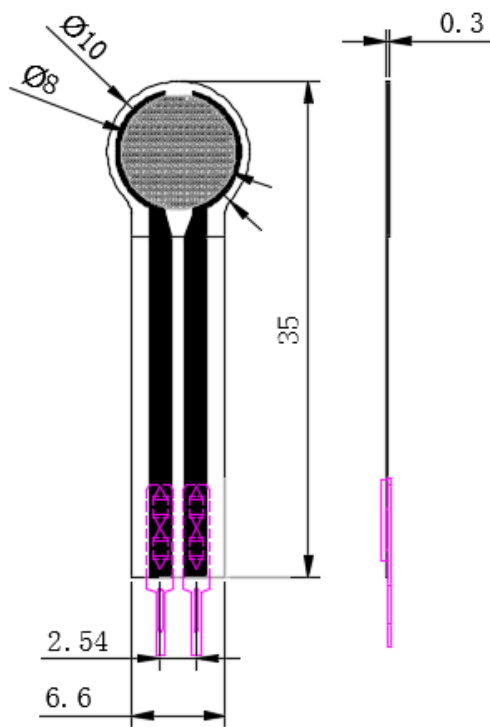

#### Note:

The above information is considered correct and is prepared for professional, competent users who are able to properly evaluate and use these data. Film sensor Technology Co., Ltd does not guarantee the accuracy of these data, the use of the damage occurred in the process of no responsibility.